

Affichage temperature DHT11 raccordé sur ESP32

Schema de raccordement



Configuration de tasmota

Tasmota avec un DHT11 raccordé sur GPIO23 de l'ESP32

FL GPIO10	None	▼	
IO GPIO12	None	▼	
IO GPIO13	None	▼	
IO GPIO14	None	▼	
IO GPIO15	None	▼	
IO GPIO16	None	▼	
IO GPIO17	None	▼	
IO GPIO18	None	▼	
IO GPIO19	None	▼	
IO GPIO21	Relay	▼	1 ▼
IO GPIO22	None	▼	
IO GPIO23	DHT11	▼	
IO GPIO25	None	▼	
IO GPIO26	None	▼	
IO GPIO27	None	▼	
AO GPIO32	None	▼	
AO GPIO33	None	▼	
IA GPIO34	None	▼	
IA GPIO35	None	▼	
IA GPIO36	None	▼	
IA GPIO39	Button	▼	1 ▼

Save

Configuration

Après un retour au menu principal (main Menu), on doit voir sur tasmota les informations de temperature et d humidité de notre DHT11



En mode "Console" , on verra defiler les infos du DHT11 : 16:30:47.928 MQT: tele/tasmota_6B2128/SENSOR = {"Time":"2023-04-10T16:30:47","DHT11":{"Temperature":22.0,"Humidity":42.0,"DewPoint":8.5},"ESP32":{"Temperature":38.3},"TempUnit":"C"}



Affichons maintenant notre Dashboard : castellab.ddnsfree.com:18xx/ui et affichons les infos en mode debug, nous voyons bien la temperature du DHT11 qui s'affiche (Cliquant sur DHT11) ici

“Temperature : 22”

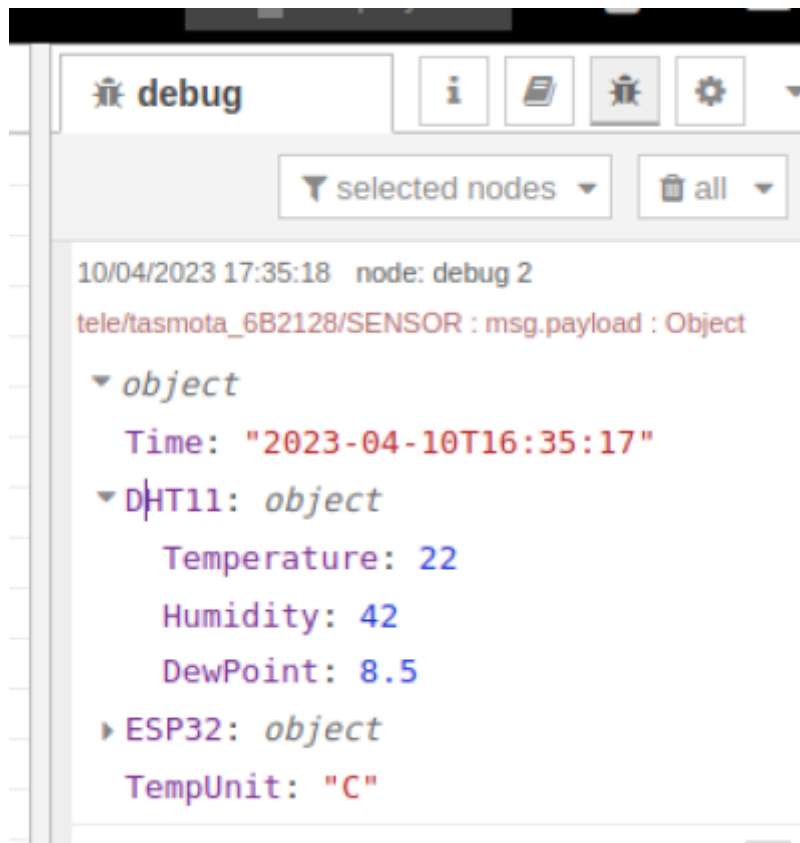

Nous inserons le noeud “Gauge” et le parametrons pour afficher uniquement la temperature



From: <https://chanterie37.fr/fablab37110/> - Castel'Lab le Fablab MJC de Château-Renault

Permanent link: https://chanterie37.fr/fablab37110/doku.php?id=faire_preparation:soireeinfo:tp:corex2:espdht11&rev=1681141412

Last update: 2023/04/10 17:43

