

Affichage temperature DHT11 raccordé sur ESP32

Schema de raccordement

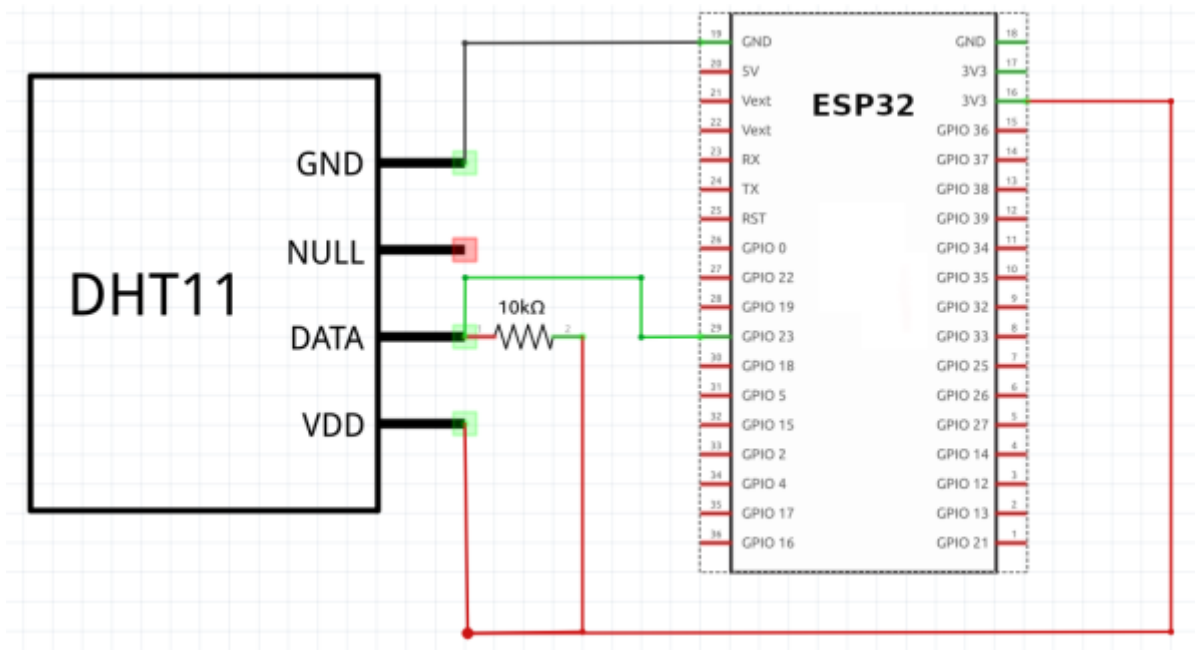

Configuration de tasmota

Tasmota avec un DHT11 raccordé sur GPIO23 de l'ESP32

FL GPIO10	None	▼	
IO GPIO12	None	▼	
IO GPIO13	None	▼	
IO GPIO14	None	▼	
IO GPIO15	None	▼	
IO GPIO16	None	▼	
IO GPIO17	None	▼	
IO GPIO18	None	▼	
IO GPIO19	None	▼	
IO GPIO21	Relay	▼	1 ▼
IO GPIO22	None	▼	
IO GPIO23	DHT11	▼	
IO GPIO25	None	▼	
IO GPIO26	None	▼	
IO GPIO27	None	▼	
AO GPIO32	None	▼	
AO GPIO33	None	▼	
IA GPIO34	None	▼	
IA GPIO35	None	▼	
IA GPIO36	None	▼	
IA GPIO39	Button	▼	1 ▼

Save

Configuration

Après un retour au menu principal (main Menu), on doit voir sur tasmota les informations de temperature et d humidité de notre DHT11

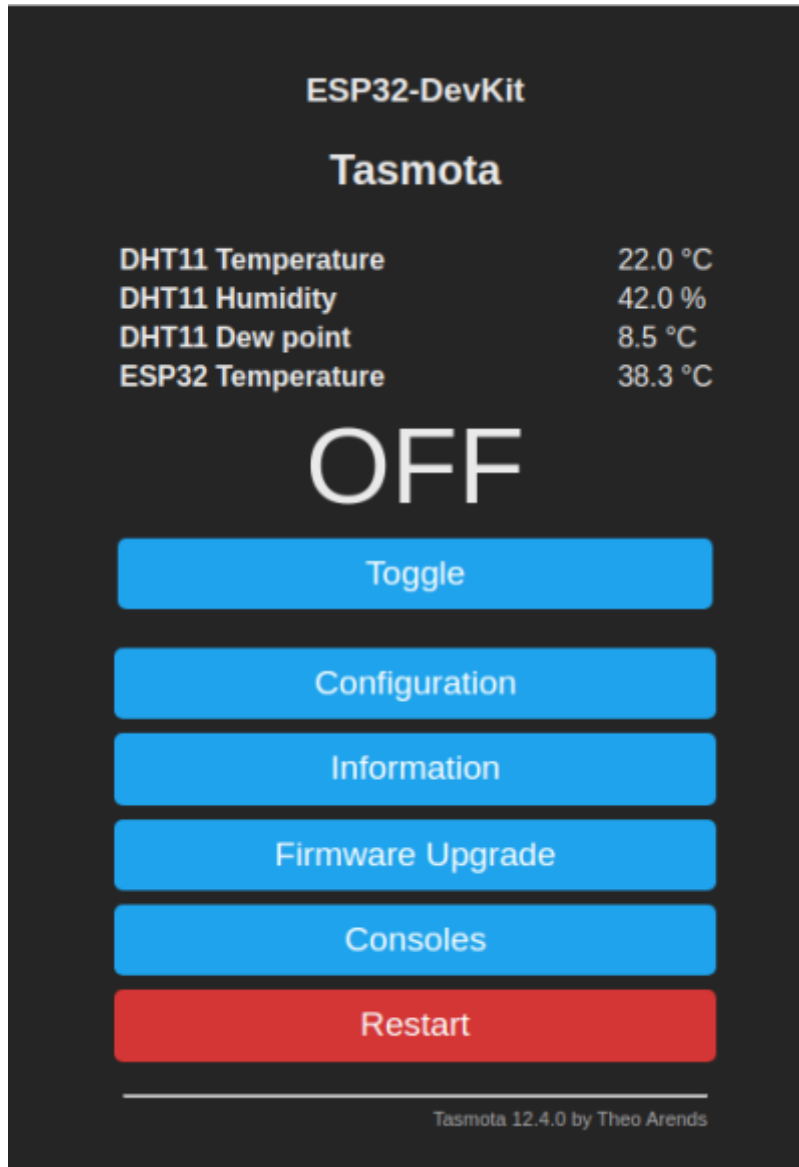

En mode "Console" , on verra defiler les infos du DHT11 : 16:30:47.928 MQT: tele/tasmota_6B2128/SENSOR = {"Time":"2023-04-10T16:30:47","DHT11":{"Temperature":22.0,"Humidity":42.0,"DewPoint":8.5},"ESP32":{"Temperature":38.3},"TempUnit":"C"}

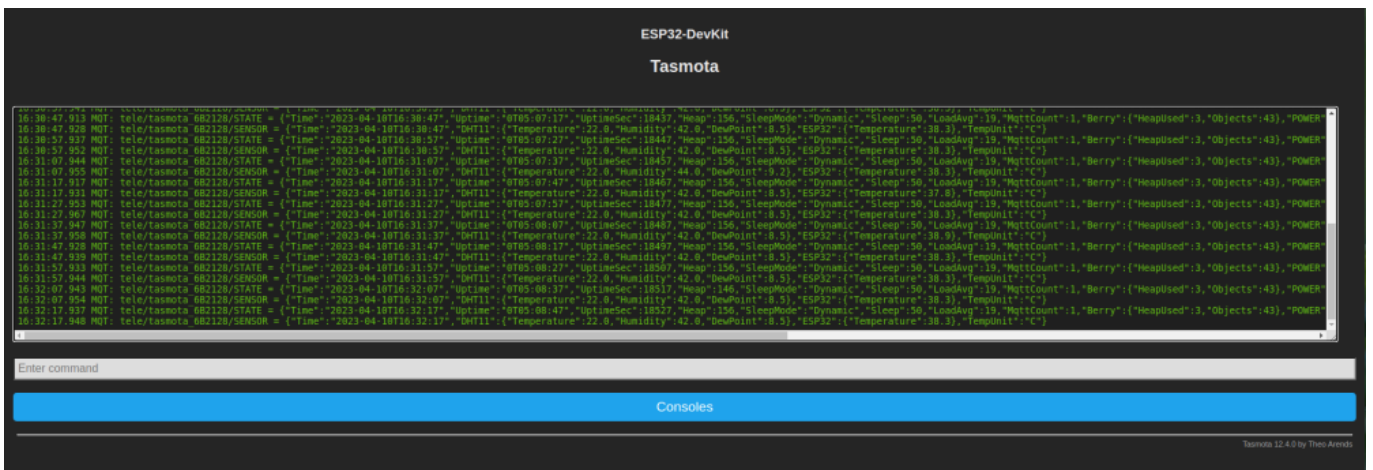

On affiche l'ecran "Dashboard" : castellab.ddnsfree.com:18xx/ui pour la gauge

Affichons maintenant notre ecran Node-red : castellab.ddnsfree.com:18xx et affichons les infos en mode debug, nous voyons bien la temperature du DHT11 qui s'affiche (Cliquant sur DHT11) ici "Temperature : 22"

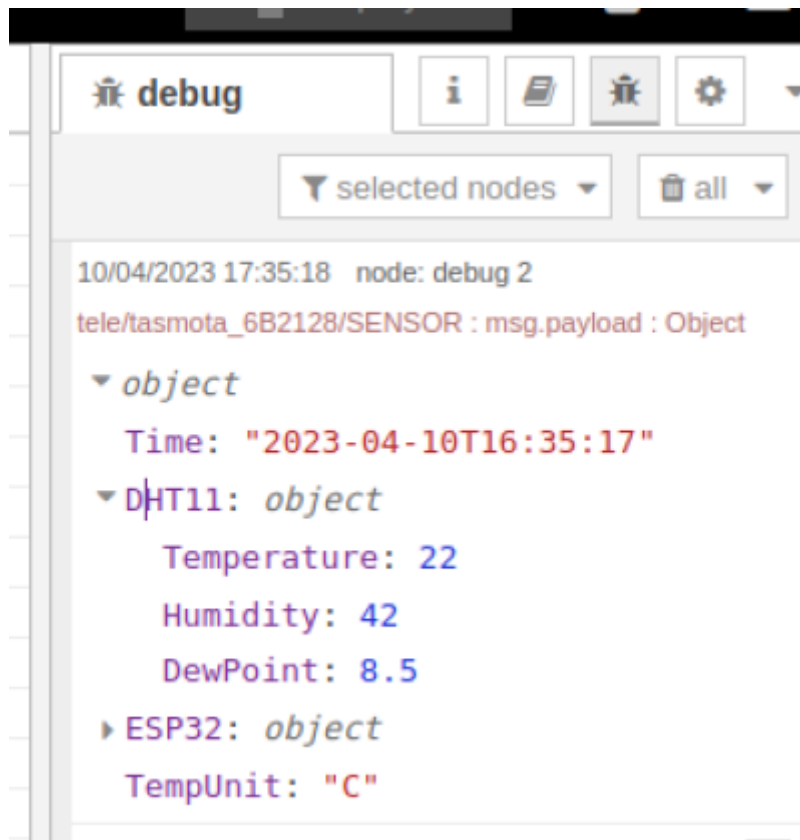





Nous inserons le noeud "Gauge" et le parametrons pour afficher uniquement la temperature. Les parametres sont les mêmes que precedement sauf le champ "Value Format" on l'on insere entre les 2 parentheses {{payload.DHT11.Temperature}} On retrouve ses infos dans la fenetre "Debug" en passant la souris sur Temperature en dessous de DHT11 et on clique sur l'icone qui apparait "Copy Path". Faire "Done" et "Deploy"



Edit gauge node

Delete Cancel Done

Properties   

Group [maison] Chambre etage 

Size auto



Type Gauge 

Label DHT11_Temperature

Value format {{payload.DHT11.Temperature}}

Units °C |

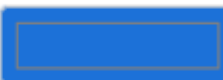
Range min 0 max 30

Colour gradient   

Sectors 0 ... optional ... optional ... 30

Fill gauge from centre.

Class Optional CSS class name(s) for widget

Name

From: <https://chanterie37.fr/fablab37110/> - Castel'Lab le Fablab MJC de Château-Renault

Permanent link: https://chanterie37.fr/fablab37110/doku.php?id=faire_preparation:soireeinfo:tp:corex2:espdht11&rev=1681142370

Last update: 2023/04/10 17:59

