

Travaux pratique Esp32 Now

Emetteur avec Bouton poussoir

Schema de raccordement

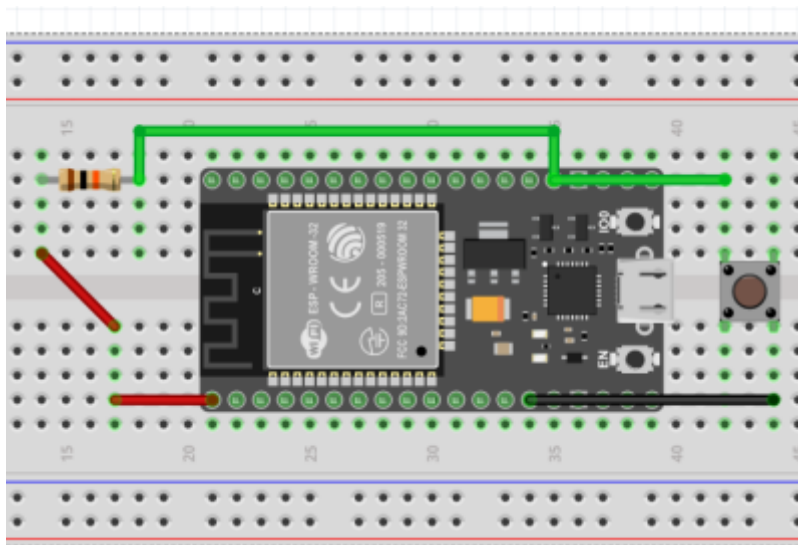
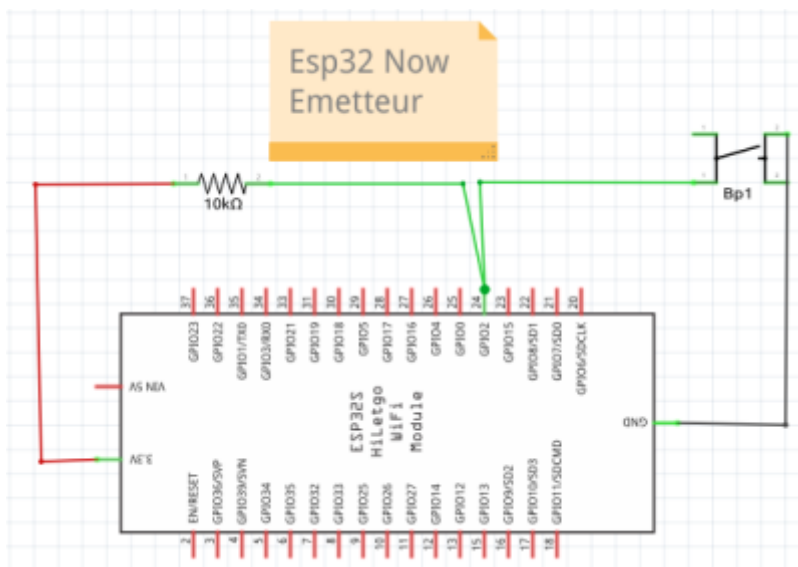

[emetteurBP.ino](#)

```

/*
  Raccorder un Bouton poussoir sur la broche 2 ( pour essai)
  Et remplacer l'adresse MAC par @Mac de votre autre ESP32
  il faut appuyer environ 1 s sur le Bp1
*/
#include <esp_now.h>
#include <WiFi.h>
  
```

```
const int Bp1 = 2;
int MemLed1 = 0;
int MemBp1 = 0;
int tempo = 50;
String result = " ";

// Indiquer l' MAC Address de l' ESP32 distant
uint8_t broadcastAddress[] = {0x58, 0xbf, 0x25, 0x14, 0x24, 0x34};

// Structure d'envoi du message
typedef struct struct_message {
    char a[32];
    int b;
    float c;
    bool d;
} struct_message;

// Creation d une structure de message appelée myData
struct_message myData;

esp_now_peer_info_t peerInfo;

// Retour de message de status l'autre esp
void OnDataSent(const uint8_t *mac_addr, esp_now_send_status_t status)
{
    Serial.print("\r\nLast Packet Send Status:\t");
    Serial.println(status == ESP_NOW_SEND_SUCCESS ? "Bouton OK" : "Erreur
Bouton");
}

void setup() {

    Serial.begin(115200);

    pinMode(Bp1, INPUT);

    WiFi.mode(WIFI_STA);

    // Initiation ESP-NOW
    if (esp_now_init() != ESP_OK) {
        Serial.println("Error initializing ESP-NOW");
        return;
    }
}
```

```
}

//Recupere le status du paquet envoyer
esp_now_register_send_cb(OnDataSent);

// test l'adress Mac , Envoi sur canal 0, et ne pas crypter le paquer
envoyer
memcpy(peerInfo.peer_addr, broadcastAddress, 6);
peerInfo.channel = 0;
peerInfo.encrypt = false;

if (esp_now_add_peer(&peerInfo) != ESP_OK){
    Serial.println("Failed to add peer");
    return;
}
}

void loop() {
    int valeurBp1 = digitalRead(Bp1); // On lit la valeur de Bp1 au début
de la boucle
    delay(tempo);

    strcpy(myData.a, " data1");
    myData.b = 0;
    myData.c = 0.5;

    //Temps 1
    if (valeurBp1 == 1 && MemBp1 == 0 && MemLed1 == 0) {
        myData.d = 1; MemBp1 = 1; MemLed1 = 1;
        esp_err_t result = esp_now_send(broadcastAddress, (uint8_t *)
&myData, sizeof(myData));
    }
    //Temps 2
    if (valeurBp1 == 0 && MemBp1 == 1 && MemLed1 == 1) {
        myData.d = 1; MemBp1 = 0; MemLed1 = 1;
    }
    //Temps 3
    if (valeurBp1 == 1 && MemBp1 == 0 && MemLed1 == 1) {
        myData.d = 0; MemBp1 = 1; MemLed1 = 0;
    }
    //Temps 4
    if (valeurBp1 == 0 && MemBp1 == 1 && MemLed1 == 0) {
        myData.d = 0; MemBp1 = 0; MemLed1 = 0;
        esp_err_t result = esp_now_send(broadcastAddress, (uint8_t *)
&myData, sizeof(myData));
    }

    Serial.println(myData.d); // affiche la valeur envoyée mydata.d ==>
```

booléen

```
if (result == ESP_OK) {  
  Serial.println("Sent with success");  
}  
if (result == " ") {  
  Serial.println("Attente d'appui !!!");  
}  
else {  
  Serial.println("Error sending the data");  
}  
delay(1000);  
}
```

Recepteur avec Led

Schema raccordement

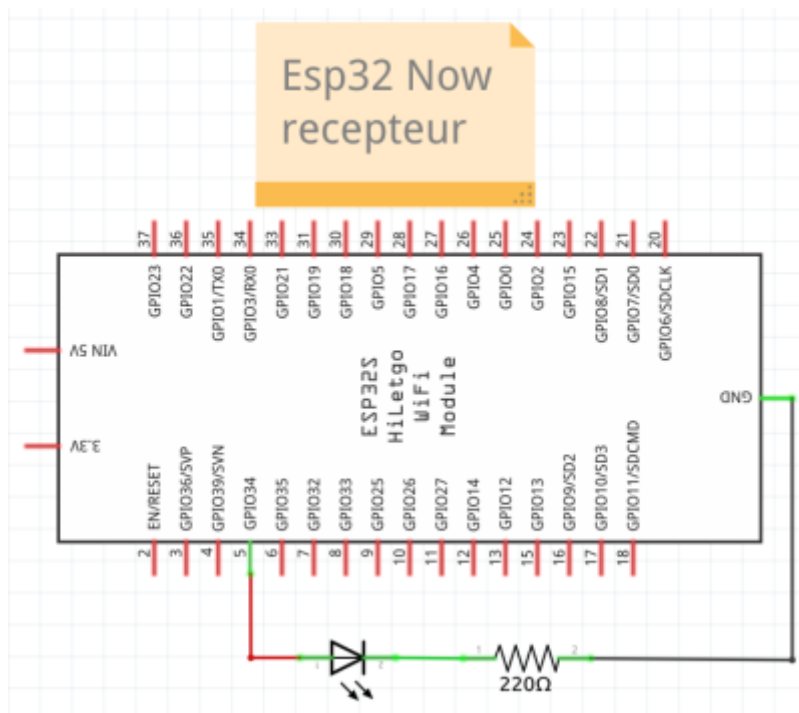



recepteur001.ino

```

/*
  Raccorder la led sur la sortie 34
*/

#include <esp_now.h>
#include <WiFi.h>

int led1 = 34;
int tempo = 50;

// Structure example to receive data
// Must match the sender structure
typedef struct struct_message {
  char a[32];
  int b;
  float c;
  bool d;
} struct_message;

// Create a struct_message called myData
struct_message myData;

// callback function that will be executed when data is received
void OnDataRecv(const uint8_t * mac, const uint8_t *incomingData, int len) {
  memcpy(&myData, incomingData, sizeof(myData));
  Serial.print("Bytes received: ");
  Serial.println(len);
  Serial.print("Char: ");
  Serial.println(myData.a);
  Serial.print("Int: ");
  Serial.println(myData.b);
  Serial.print("Float: ");
  Serial.println(myData.c);
}

```

```
Serial.print("Bool: ");
Serial.println(myData.d);
Serial.println();
}

void setup() {
  // Initialize Serial Monitor
  Serial.begin(115200);
  pinMode(led1, OUTPUT);

  // Set device as a Wi-Fi Station
  WiFi.mode(WIFI_STA);

  // Init ESP-NOW
  if (esp_now_init() != ESP_OK) {
    Serial.println("Error initializing ESP-NOW");
    return;
  }
}

void loop() {
  esp_now_register_recv_cb(esp_now_recv_cb_t(OnDataRecv));
  delay(1000);

  if (myData.d == true) {
    digitalWrite(led1, HIGH);
  }
  if (myData.d == false) {
    digitalWrite(led1, LOW);
  }
}
```

From:

<https://chanterie37.fr/fablab37110/> - Castel'Lab le Fablab MJC de Château-Renault

Permanent link:

<https://chanterie37.fr/fablab37110/doku.php?id=start:arduino:esp32:tp:now&rev=1730971863>

Last update: 2024/11/07 10:31

